

LED Strip Datasheet

Single Colour Led Tape

4.8W per/m

DC Output:24VDC/12VDC

Diodes:SMD2835/3528

Life Span:50000 Hours



Product Code	IP Rating	CCT-[Lumen/Meter]				Led Qty [LED/M]	CRI	PCB SIZE		
		WW	WW	NW	CW			Cutting points(mm)	Width (mm)	Height (mm)
		2200K	2700K	4000K	6000K					
ALSTP2835-4.8W60sR90P20	IP20	330	380	410	430	60	>90	100	8	1.4
ALSTP2835-4.8W70sR80P20	IP20	520	630	660	670	70	>80	100	8	1.4
ALSTP2835-4.8W60sR90P65	IP65	330	350	380	400	60	>90	100	10.5	4.3
ALSTP2835-4.8W60sR90P68	IP68	-	310	340	350	60	>90	100	10.5	4.3
ALSTP3528-4.8W60sR80P20	IP20	-	370	400	420	60	>80	100	8	2.3
ALSTP3528-4.8W120sR80P20	IP20	-	485	500	510	120	>80	50	8	2.3
ALSTP3528-4.8W120sR80P65	IP65	-	445	480	485	120	>80	50	10.5	4.3
ALSTP3528-4.8W60sR80P65	IP65	-	440	470	475	60	>80	100	10.5	4.3
ALSTP3528-4.8W120sR80P68	IP68	-	385	405	410	120	>80	50	10.5	5.3
ALSTP3528-4.8W60sR80P68	IP68	-	375	395	400	60	>80	100	10.5	5.3

RITZ apartments, Manchester



Ribbon series

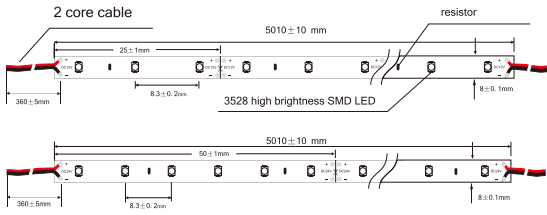

Silicone-cased series

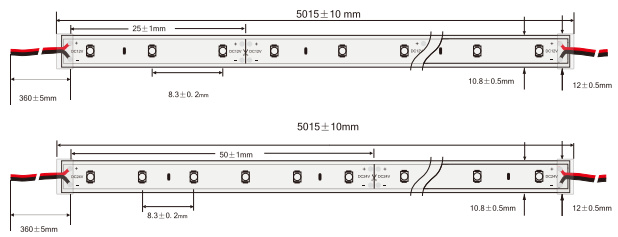

Dropper series

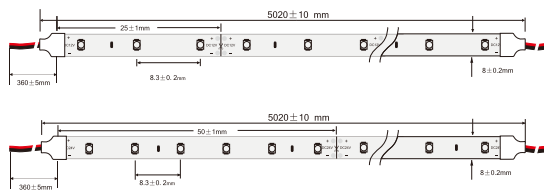

Jade series

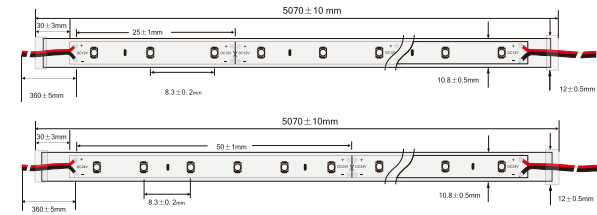

Diamond series

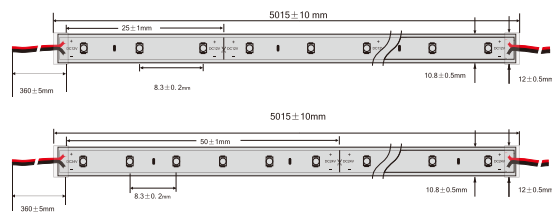

Feature:

- DC 12/24V low-voltage power supply, security and energy efficiency
- High brightness low power consumption
- Led lighting angle: 120°
- Led quantity: 120 leds/m
- Operation temperature: -20-50
- Life time: 50,000hours °C
- Dimmable by using dimmer controller
- Water-proof rating: IP20

Lamps and lanterns light intensity curve

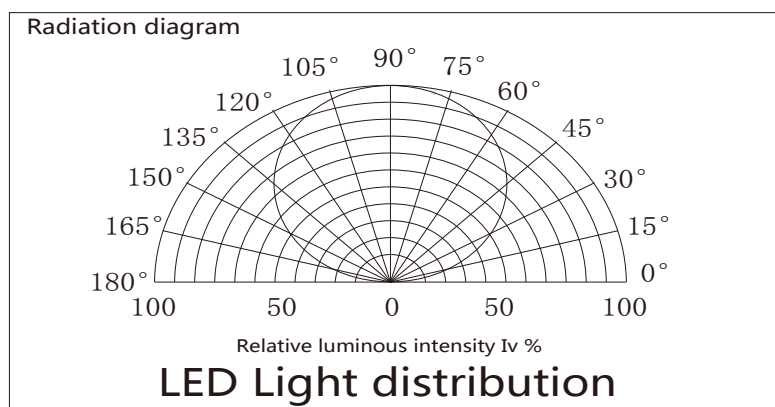

connection ways

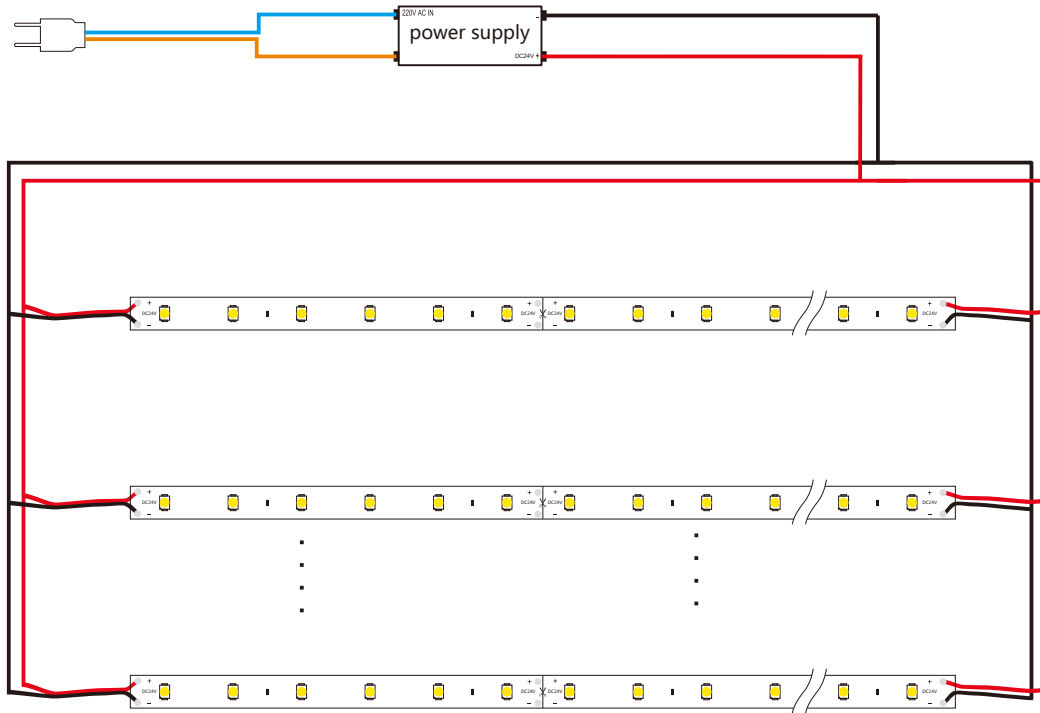

Package Details



Operation temperature: -20~50°C
Storage temperature: -30~80°C
Packing: 5meters led strip as one roll, It can hold a roll of 20 meters at most, one roll put into one bag, packed into one carton.

Ribbon series: 30bags/carton
Dropper series: 20bags/carton
Silicone-cased series: 15bags/carton
Diamond series: 25bags/carton
Jade series: 15bags/carton

One box with 2 inner boxes